

Timken 463/452D tapered roller bearings

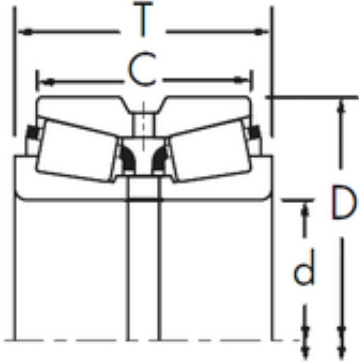

Bearing No. 463/452D

Size	47.625x107.95x65.09 mm
Bore Diameter	47,625 mm
Outer Diameter	107,95 mm
Width	65,09 mm
d	47,625 mm
D	107,95 mm
T	65,09 mm
C	53,975 mm
R	4,8 mm
r	0,8 mm

463/452D Bearing 2D drawings and 3D CAD models