

Timken 26131/26282D+X1S-26131 tapered roller bearings

Bearing No. 26131/26282D+X1S-26131

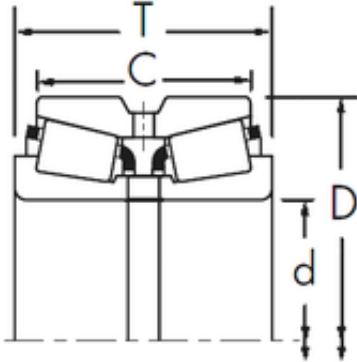

26131/26282D+X1S-26131 Bearing 2D drawings and 3D CAD models

Size	33.338x71.438x42.862 mm
Bore Diameter	33,338 mm
Outer Diameter	71,438 mm
Width	42,862 mm
d	33,338 mm
D	71,438 mm
T	42,862 mm
C	36,512 mm
R	3,5 mm
r	0,4 mm